

# Installation Guide

Version 1.0 | 04.23

**hup!** - A Building Revolution from Ultraframe

**hup!**<sup>®</sup>  
The better way to build



### Five Times More Energy Efficient - Easy Building Regulations

- Five times more energy efficient than the average UK home.
- Components compliant with Part L June 2022 Building Regulations.
- Solid roofs with U-Values less than 0.15W/m<sup>2</sup>K for England and 0.13W/m<sup>2</sup>K in Scotland.
- Walls with a U-Value of 0.17W/m<sup>2</sup>K, exceeding Building Regulations.



### Less Trades – Easy Project Management

- No bricks required – range of authentic looking wall finishes.
- Designed to be fitted by one conservatory team.
- Comprehensive fitting team training provided.
- Design, specify and price in one easy U-Design order.

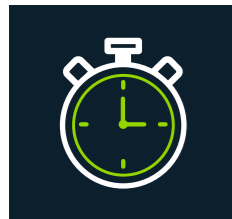

### Five Times Faster to Build – Collect Cash Quicker

- 100% pre-fabrication.
- Rapid wall and roof connections.
- 10m<sup>2</sup> of wall built in minutes.
- Can be built in most weather conditions unlike brick.



### Ultimate Design Flexibility – Convert More Sales

- Choose from five Ultraframe roofs.
- Compatible with any wall finishes.
- Configurable to any window and door layout.
- Perfect for extensions, conservatories, transformations, and garden homes.



### Engineered by Ultraframe – High Quality Finish

- BBA approved Ultrapanel technology from a BBA approved factory.
- Designed to accommodate on site tolerances.
- Precision engineered for a consistent high quality finish.
- No cold bridging.

## Introduction

Thank you for choosing hup!. This guide is designed to make building as straightforward as possible. Before you commence the hup! build, please take a moment to read the guide. This guide is written on the basis that a qualified surveyor has undertaken correct checks for the capability / structural performance of any existing framework / walls / foundations to verify they are fit for purpose. Any feedback - positive or negative - is welcomed so we can make our systems even better.

## Contents

Tools required	04	Glass Roof / Hybrid Roof	12
Fixing summary	04	Tiled Roof	13
Product components / assembly	05	Flat Roof	14
Pre-build	06	Hybrid Roof	14
General build	07	Gable End & Lean	14/15
Full height openings	09	Tiled Roof 0.12 U-Value	15/16
Walling below an opening	09	Finishing	19/20
Walling above an opening	10	Wall finish	21/22
Securing walling panels	11	Wiring	22/23
Glass Roof	11		

For everything you need to know about hup!, including guides and explainer videos, visit [www.trade-hup.co.uk](http://www.trade-hup.co.uk)

### Building Regulations

The hup! wall system has been assessed and pre-approved by Assent and JHAI (national building inspector networks) to make Building Regulations easy.



## Product

The kit is supplied with a location plan, a quality control checklist for the box in which this guide arrives and, of course, this installation guide. The location plan is used to match individual components to their respective positions.

Our numbering convention always starts at the top left, as you look from outside back at the front elevation.

### Fixings Supplied



GPHS – Self Drilling Countersunk 4.2 x 38mm screw.



SLP004 – Structural Post Fixing Kit (only supplied if structural post is specified).



HSCCA – Winged Batten Screw (only supplied if battens are specified).

### Fixings Not Supplied



Host wall tray to host wall example fixing: Concrete Frame Screw 7.5x70mm. Fixing choice is dependent on substrate.

### Tools/Materials Required

- 300mm Width DPC
- Drill/Screwdriver
- No. 2 Square Drive (Supplied)
- No. 2 Torx Drive (for HSCCA Batten Fixings)
- 13mm Socket (for Structural Post Fixings)
- Deadblow Hammer or White Rubber Mallet
- Tape Measure
- Laser Level/Stringline
- Spirit Level
- Utility Knife
- Tin Snips
- Sealant Gun
- Mortar Gun (for Brick Mesh)
- Brick jointer 1/2 x 5/8" (for Brick Mesh)
- 6mm notched trowel for applying adhesive (for Brick Mesh)
- Plasterers Hawk (for Brick Mesh)
- Small pointing trowel (for Brick Mesh)
- Polythene or similar floor protection (for Brick Mesh)



Base tray to foundation example fixing: M6 x 85mm Concrete Bolt with a minimum 1kN pull out. Fixing choice is dependent on substrate.

## Health and Safety

Site safety is paramount. The Construction (Design & Management) Regulations 2015 apply to the whole construction process, on all construction projects from concept through to completion. Compliance is required to ensure construction projects are carried out in a way that secures health and safety. The installation company shall be responsible for the safety of all of the fitting team, the customer and members of the public.

The Surveyor should have carried out a risk assessment to reduce risk on site and this should have been discussed with you prior to starting.

Please use safe working platforms and ladders that comply with BS EN 131. Always use equipment in line with manufacturers recommendations. Personal Protective Equipment - such as goggles, gloves, mask and ear defenders – should be used when appropriate.

Careful consideration should be given to the safe disposal of all packaging - packaging is predominantly made from recycled materials and can be readily recycled.

## Product Assembly

The hup! building system is designed to be used with any of the five Ultraframe roofing systems

hup! walls, when combined with the choice of one of five different roofing systems, delivers a lightweight yet robust structural solution which can be built and made watertight in a fraction of the time it takes to build the equivalent structure using standard construction methods.

### Wall Panel Components

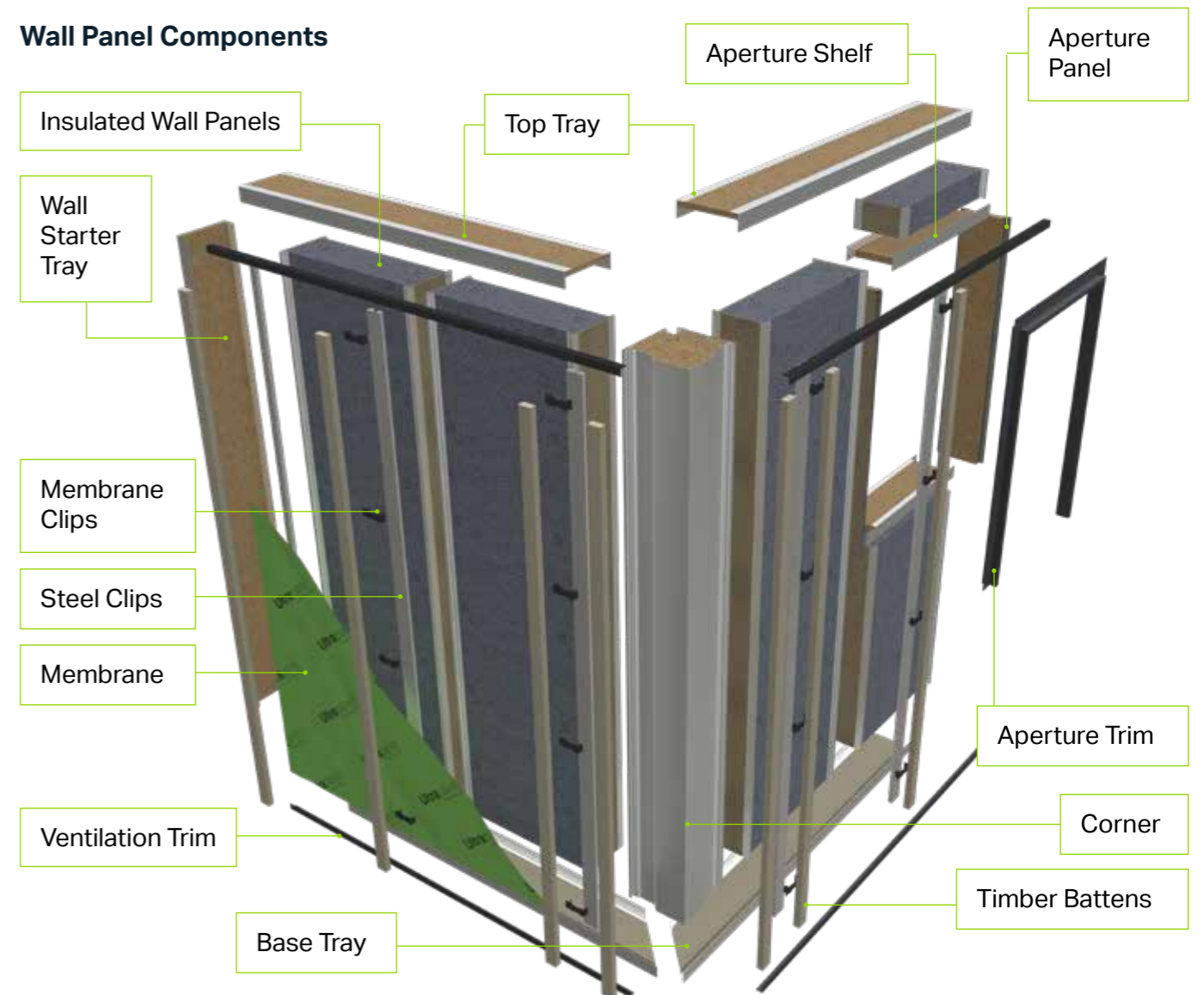

### Four Roof Types



Glass Roof

Hybrid Roof

Tiled Roof

Flat Roof



## Pre-build

Ensure the host wall is plumb and all measurements and set out positions are taken from a plumb datum line.

hup!  
The better way to build

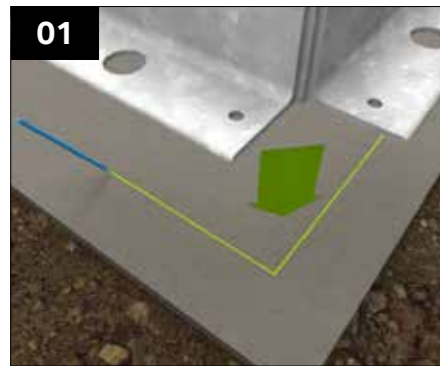

If a structural corner post has been specified, this is to be fitted to the foundations prior to the laying of the external brickwork. When marking out care should be taken to ensure this is positioned accurately. All dimensions including diagonals are to be checked against the build paperwork. This post will be used to set out the brickwork.

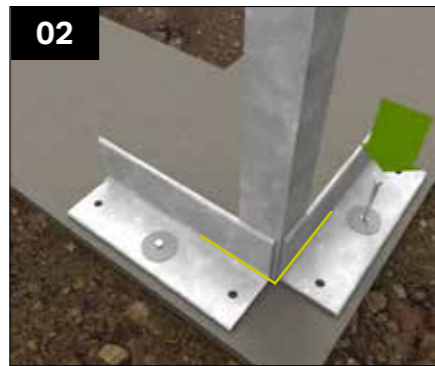

Drill 10mm holes in the concrete footing centrally through the two large holes in SLP002 structural post. Temporarily clamp the post in place using SLP004 kit (M8 anchor bolts, washers and packers).



Ensure the post is positioned precisely then drill through the two smaller holes and secure in place using concrete anchors provided in SLP004 kit.



Begin the first course of brickwork, using the inside face of the structural post as a datum. Continue the brickworks as desired up to DPC level.

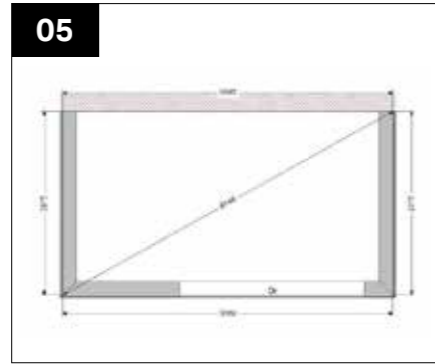

Ensure the basework is square and accurate by checking diagonals against provided build paperwork/location plan.



Where the walling panels abut the host wall a vertical DPC (NOT SUPPLIED) is required. To mark the position, strike a vertical line at the inside face of the outcourse of the foundation brickwork (or 100mm in from external base).



Install a vertical DPC suitable for the local environmental conditions to create a continuous cavity.



Insert the DPC into the channel created, this will require folding into an 'L' shape, the DPC may require cutting to seat correctly. Once the walling panels are fitted this will then be folded again to form a 'Z' shape. If required repeat this and the previous two steps on other junctions with the existing structure.



Ensure base is level. If required level off with metal or slate shims or a bed of mortar.

hup!  
The better way to build

## General build

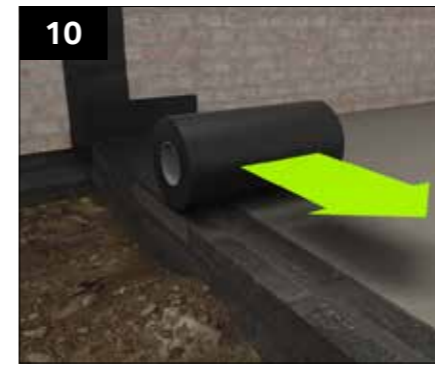

Position horizontal DPC (NOT SUPPLIED, 300mm min. recommended) around the perimeter of the base aligning with the external face and lapping up the host wall. Where walls are to be positioned, the DPC should run past the base trays, by minimum of 50mm, allowing for it to be lapped up the aperture face of walling.

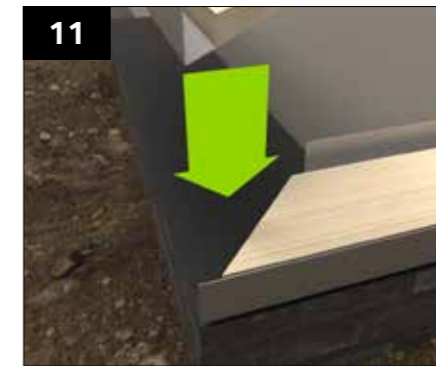

Referring to the location plan, loosely position the base trays on top of the DPC. Where walls are to be positioned, the DPC should run past the base trays, by minimum of 50mm, allowing for it to be lapped up the aperture face of walling.



The host wall tray can be used to strike a plumb datum line down from the host wall. This can then be used to find the correct position for the base trays.

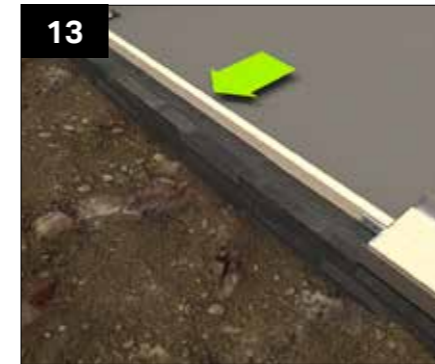

These trays can then be temporarily joined together using the provided set out battens and the tray steels as a datum, this step is optional primarily to assist with accurate tray positioning.



Through the punched holes in the base trays pre-drill the foundations using appropriate size drill bit for fixings (not supplied). Example fixing: M6 x 85mm Concrete Bolt with a 1kN pull out @ 600mm max centres or similar suitable approved for the substrate.

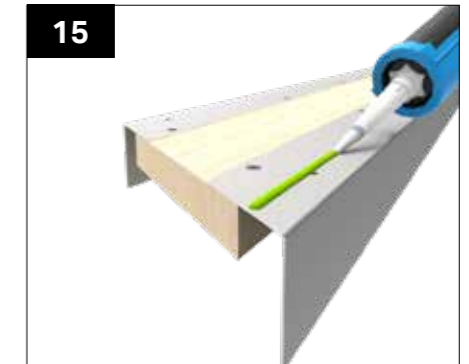

Once satisfied with the tray positioning run a bead of low modulus neutral cure sealant on the underside of each base tray and press it onto the DPC in its final location.

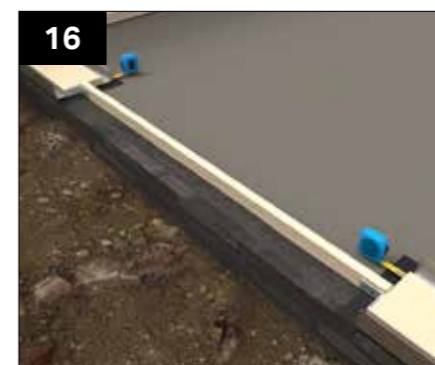

Perform dimensional checks to ensure the trays are positioned precisely.



Fix the trays down to the basework using appropriate fixings (NOT SUPPLIED) through pre punched holes. M6 x 85mm Concrete Bolt with a 1kN pull out @ 600mm max centres or similar suitable approved for the substrate.



The setting out battens can now be removed, these should be set aside for use again later.





## General Build

hup!  
The better way to build

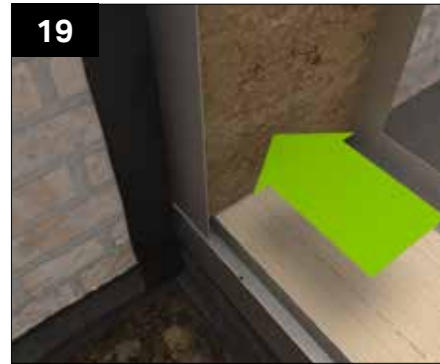

At the host wall, locate the host wall tray in position onto the base trays below. Ensure the vertical DPC is trapped in position and extends beyond the tray steel, the extra DPC will be folded over later.



Ensuring the host wall tray is plumb and level secure it into the host wall using appropriate fixings (NOT SUPPLIED). Example fixing: Concrete Frame Screw 7.5x70mm this may require pre-drilling at staggered 300mm centres or other similar approved fixing for the substrate, avoiding mortar joints.

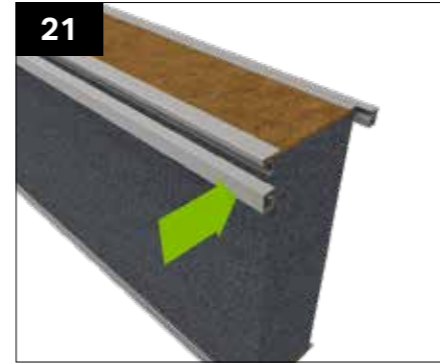

Attach the half clips to the host wall side of the panels that abut the host wall. If cable management panels have been specified, ensure that the conduit is facing internally and is positioned to the lower section of the panel.



Lift the first panel into position in between the host wall/base tray steel. The half clips should run through to touch the steel angles at ground level.

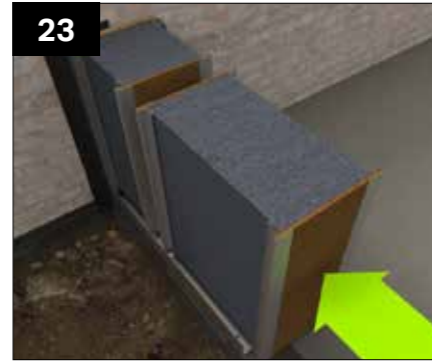

Position the following panel against the previous panel.

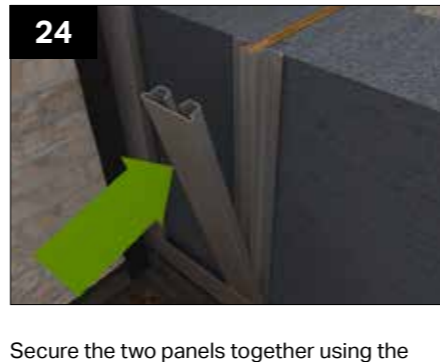

Secure the two panels together using the steel full clips. This can be done by knocking the clips onto the panel, it is helpful for a second person to brace the opposing side whilst this is being done. **PLEASE NOTE:- for Tiled Roof & Flat Roof the clips will extend beyond the tops of the walling panels and internal and external clips will differ in length.**



The previous two steps can then be repeated for the remainder of the standard walling panels.

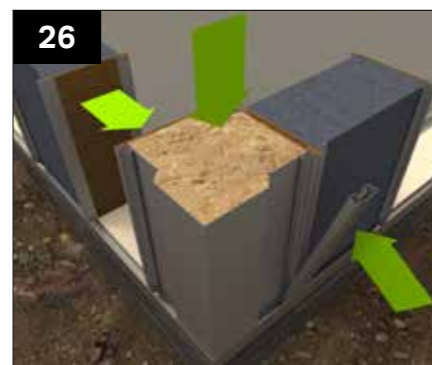

Walling corners are installed using the same methodology as the walling panels. The corners are lifted into position on the base trays at the corner. These can then be joined to the walls abutting using full clips.



If a structural corner post has been specified, this will already have been fitted at foundation level in the pre-install. Secure the walling corner into the post using the GPHS fixing at 300mm centres.



hup!  
The better way to build



When an opening in the wall is reached, an aperture panel is used to terminate and allow for secure window fixing. Locate the relevant aperture panel and position this against a walling panel, as shown on the location plan.



Fit the walling panel and aperture panel together using the steel full clips, using the same method as previously used for attaching walling panels together. **Please note:- for Tiled Roof & Flat Roof the clips will extend beyond the tops of the walling panels and internal and external clips will differ in length.**

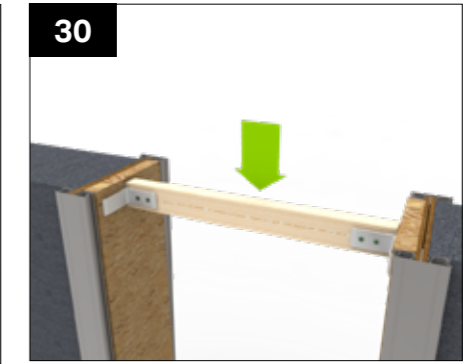

If full height openings are present the set-out battens used previously can be utilised to tie the top of the opening together, ensuring accurate set out towards the top of the wall.

## Walling Below an Opening

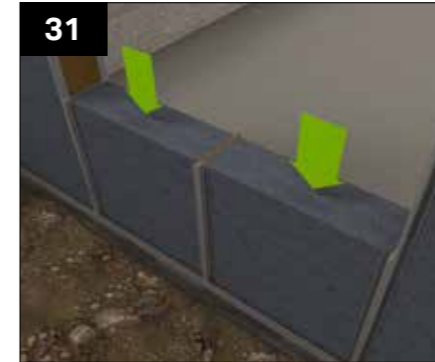

Position the full row of short walling panels within the base trays next to one another.



Where the short run meets the full height walling an aperture panel will be required above each short end panel.

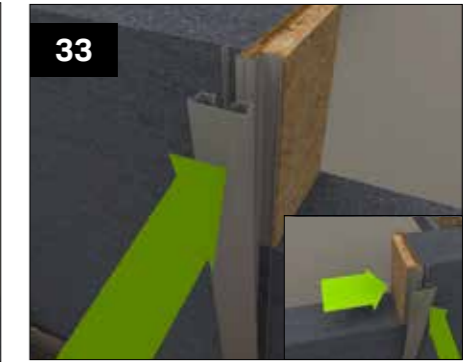

A full clip can then be used to secure both the short walling panel and aperture panel to the full height walling panel. This clip is fitted using the same method as previously used for attaching walling panels together. This process will need to be repeated for the other end of the opening.



The run of short walling panels can then be joined together using full clips as per the full height panels.



Once all panels are securely clipped together, the aperture tray can be lowered into position in between the aperture panels, capping off the walling panels below and allowing for frames to be securely fixed into the walling system.



The tray is to be fixed into each of the full clips below the wall with two fixings and the full clip to the side of the opening with four fixings through the pre-punched holes using the GPHS fixing provided. **Please note that indication lines are on the clip to aid with fixing location.**

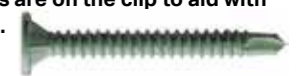



## Walling above an opening

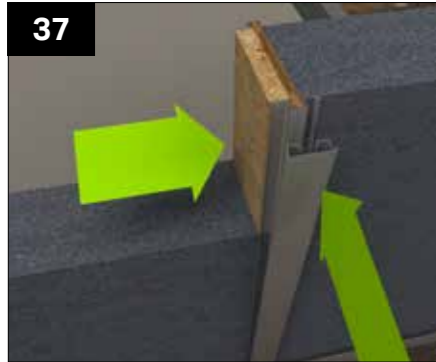

Aperture panels are to be fitted in place either above short walling panels or above the base trays. Clips should finish inline with the tops of the aperture panels and not run the full length of the taller walling panels.



Lower the aperture shelf into position between the walling panels at either side of the opening and onto the aperture panels below.

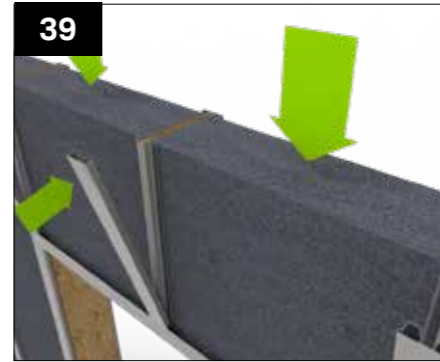

Position the walling panels into the aperture shelf and secure together using full clips. **PLEASE NOTE:- for the Tiled Roof and Flat Roof the clips will extend beyond the tops of the walling panels.**



Ensuring the tray is level and propped at the centre (prop NOT SUPPLIED), fix the tray into the walling panel clips at both ends with four GPHS fixings and for each walling panels on the tray with two GPHS fixings through the pre punched holes.



Leave the prop in place, this can be removed later once the clips are secure into the beam or tray above (roof dependant).

## Securing Walling Panels



Ensure that the building is plumb and level.



Secure the walling panels into the host wall tray using the GPHS fixings provided at 300mm centres.



Secure the base trays through the two pre-punched holes into each of the walling panels/clips using the GPHS fixing provided.

## Securing Walling Panels



At the top of the walls (these vary with roof type), follow the relevant roof steps shown later in the guide for fixing methods.

## Boundary Wall (Limited Access)

Follow the standard installation steps up to step 12 prior to completing these steps.

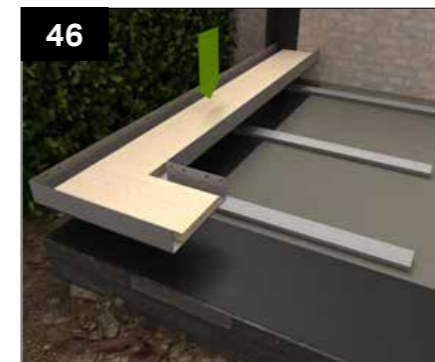

Position the base tray on top of provided steel skids. Following steps up to 12 in the general installation to position the base tray, mark this position, however do not fix down to the base at this point.



At the host wall, position the host wall tray onto the base tray below. Ensure the vertical DPC (step 8) is located into the brickwork and extends beyond the tray steel, this will need to reach the wall once angled away for access.



Ensuring the host wall tray is plumb and level, using the hinged element of the host wall tray secure into the host wall. When fixing into the host wall, ensure that the fixings are positioned to the bottom of the slotted hole as shown to allow the tray to lower once the skids are removed

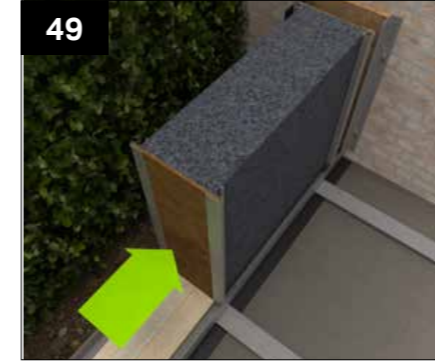

Attach half clips and position the first walling panel in place following the standard process as shown from step 21 and 22, securing the host wall tray and base trays together.

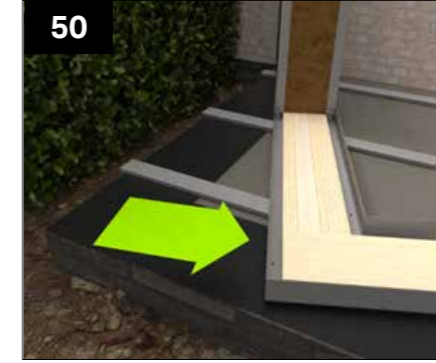

The base tray can now be angled away from the boundary by sliding on the skids to enable access. The hinged steel should bend along the perforations, whilst stabilising the wall.



This section of wall can then be constructed following the standard process shown from step 23, it may be advisable to fit the roof eaves beam whilst external access is available. Once the wall has been cladded externally with calcium silicate board and any final wall finishing it can then be moved into its final position





Apply sealant to both the top of the DPC where the base tray will rest and a bead of sealant along the vertical DPC at the host wall.



Manoeuvre the wall into its final marked position. This can be done by using a pry bar to leverage the wall into place. When using a pry bar, position this in line with the vertical wall clips to prevent distortion of the base tray.



Once the wall has been swung into position, the fixings secured into the host wall can be loosened slightly to allow the wall to drop once the skids are removed.



The skids can now be removed from below the host wall, again a pry bar can be used to take the load of the wall whilst the skids are removed (ensure lifting directly under vertical steel wall clips).



Once all skids have been removed, the host wall fixings can be retightened. If required there are additional holes in the steel angle for securely fixing into brickwork.



Finally drill through the pre-punched holes and secure base tray into slab through pre-punched holes as shown in step 14.



Lower the walling trays onto the top of the walling panels, capping the top of the walls off.



Ensure the trays are level, now secure the walling trays in place into each panel clip through the two pre-punched holes in the tray steel and into each walling panel clips using GPHS fixing.



Unroll the membrane over the walls allowing this to sit slightly below DPC level (around 10 mm). Ensure that any joins in the membrane overlap by a minimum of 100mm horizontally and 150mm vertically. This can be clipped in place using the membrane clips provided. The membrane detail at the top of the wall is shown in the following steps.

### Glass Roof/Hybrid Roof with cornice



If the roof does not require a cill, the roof membrane should be folded over the top of the walling as shown above. The following steps depict the eaves beam installation.

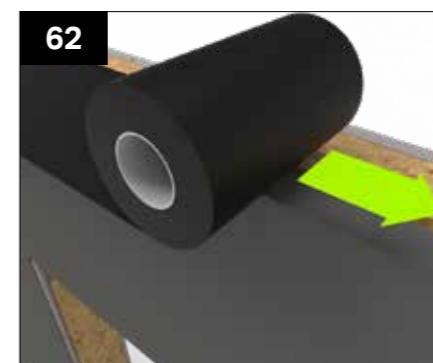

If the roof does not require a cill, apply DPC to the top of the top tray, this will be trapped under the eaves beam and lap over the walling membrane.

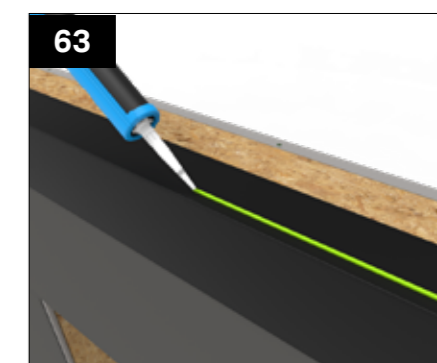

Run a bead of low modulus neutral cure sealant on top of the membrane around the perimeter of the walls and frames where the eaves beam will sit.

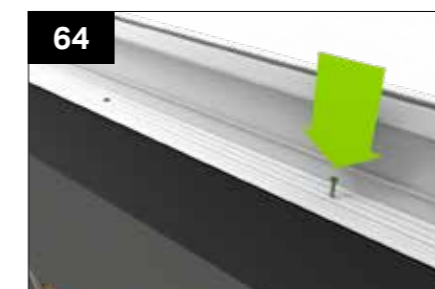

Lower the eaves into position aligning with the external wall. Secure the eaves beam down to the top tray using the GPHS provided fixing at 450mm centres and within 200mm of the eaves beam ends. Once secured, fixing heads are to be sealed with an appropriate sealant.



## Glass Roof/Hybrid Roof

WITHOUT CORNICE



**65**  
If the roof does require a cill: the following steps depict the eaves beam and cill installation. The walling membrane should be folded over the top of the wall and lapped up the internal face of cill as shown above.

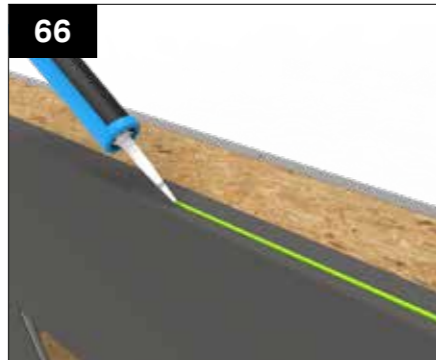

**66**  
If the roof does require a cill: run a bead of low modulus neutral cure sealant across the top of the membrane over walling trays and frames.

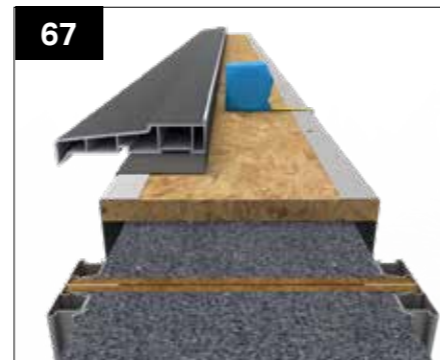

**67**  
Lower the reinforced cill (not included) onto the walls. The internal face of the frames (if 70mm frames are used) is to sit 70mm inboard from the external wall steel datum (145mm from the internal). This is the outermost steel on the top tray.

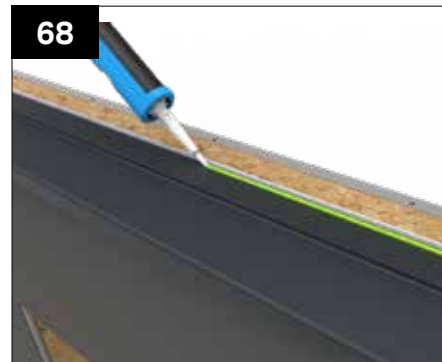

**68**  
Run a bead of low modulus neutral cure sealant along the top of the cills.



**69**  
Lower the eaves into position on the cill. Secure the eaves beam down through the cill and into the top tray using appropriate fixings (NOT SUPPLIED) at 450mm centres and within 200mm of the eaves beam ends. Once secured, fixing heads are to be sealed with a low modulus neutral cure sealant.



**69A**  
Follow the Glass Roof Guide (JN: 3773) to install the remainder of the roof. Once complete, return to this guide for external and internal finishing of the walls.



**69B**  
Follow the Livinroof Guide (Hybrid Roof) to install the remainder of the roof. Once complete, return to this guide for external and internal finishing of the walls.

## Tiled Roof

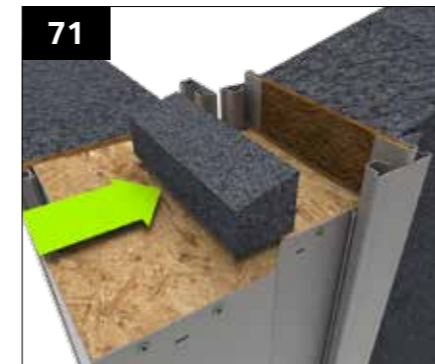

**71**  
If the building has a gable end, a gable infill wedge is supplied. Apply sealant to the wedge where it makes contact with the walling corner and panel. This is to then be pushed into place as shown, once the beam is in position this wedge will be trapped.



**72**  
Lower the eaves beam onto the walling panels aligning the internal face of the eaves beam so that the internal walling clips are able to run through.



**73**  
If beam returns around corner, first fix the provided OSB beam shelf to the underside of the beam using 5 of the GPHS050 screws, aligning the edge and the corner of the OSB shelf with the edge and corner point of the beam.



**74**  
Position the beam on the corner and ensure square and level. Screw down through the OSB shelf into the top of the corner using 3 of the provided GPHS050 screws. Next fit the return beam and position correctly ensuring square and level. Screw up through the underside of the OSB shelf into the underside of the return beam using 3 GPHS050 screws.



**75**  
Secure the beam in place by fixing through the internal walling clips into the beam with two GPHS fixings and into the walling panels with two GPHS fixings for every full clip.

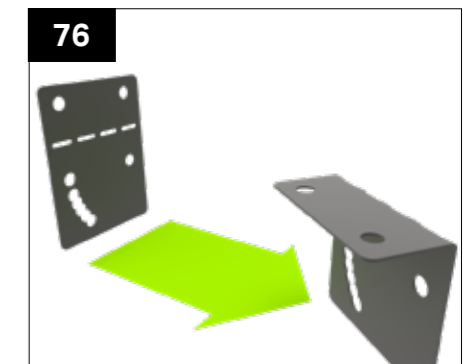

**76**  
To secure the external side of the beam, bend the steel brackets to a 90° angle as shown.



**77**  
Position the brackets against the walling clips and fix twice into the clips and twice into the beam above with the GPHS fixings provided.



**78**  
On a gable end and walling corner use these same brackets to secure the clips to the gable panel/eaves by bending to 90°, positioning it up against the underside of the beam and fixing into the clips using two GPHS fixings and into the gable panel/eaves with two GPHS fixings per full clip.



**79**  
If the roof has a box gutter: The beam sitting on top of the wall is to be prefitted with the OSB cleat and lowered into position.



## Tiled Roof



The beam on the box gutter side is to be lowered into position and secured in place using the angle provided. Fixed using the GPHS fixing through the pre-punched holes, three into the beam and two into full clips and a single fixing into the host wall tray.



Unroll the membrane over the walls allowing this to sit slightly below DPC level (around 10 mm). Ensure that any joints in the membrane overlap by a minimum of 100mm horizontally and 150mm vertically. This can be clipped in place using the membrane clips provided. The membrane detail at the top of the wall is shown in the following steps.



When applying the membrane ensure to lap up the underside face of the beam to ensure joints are well weathered.



Follow the Ultrarroof Guide (Tiled Roof) for the remainder of the roof installation. Once complete return to this guide for external and internal finishing of the walls.

## Tiled Roof 0.12 U-Value (for Scotland and Wales)

To achieve the 0.12 U-Value, an additional layer of 60mm PIR insulation board is required under the current EPS panel.

The following additional parts will be supplied and all components cut to size. \*Gable situations.

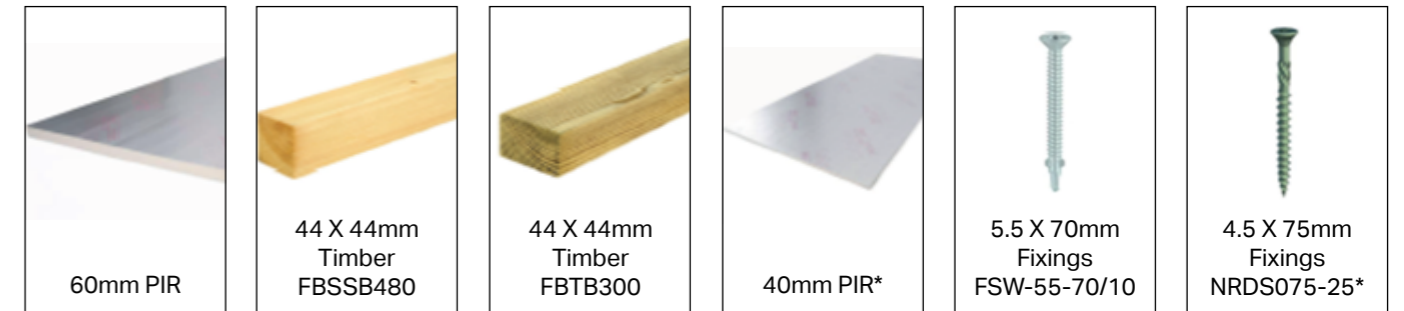

Please follow these steps for installing the additional layer.

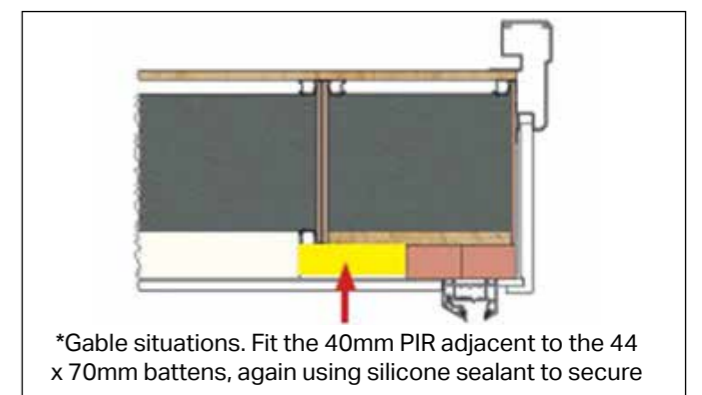
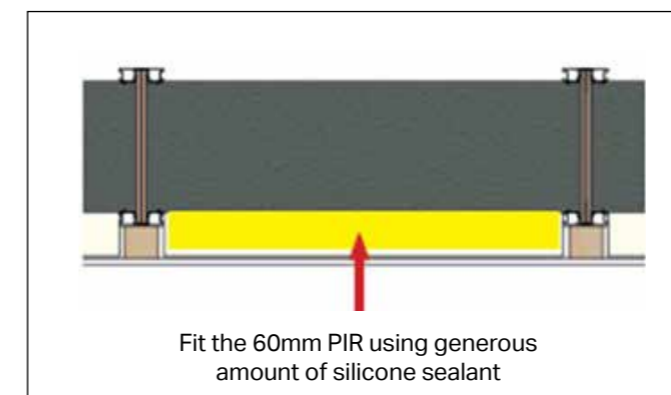
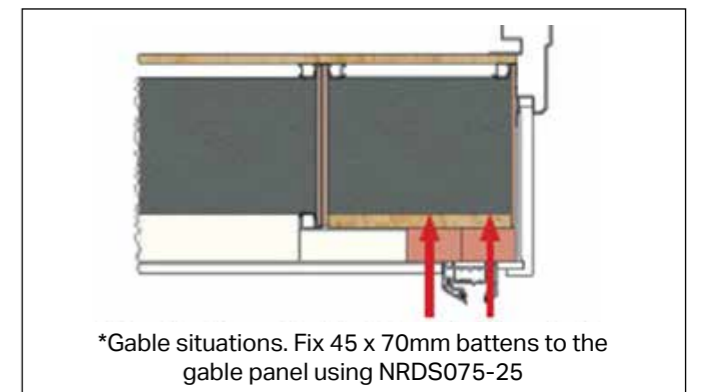
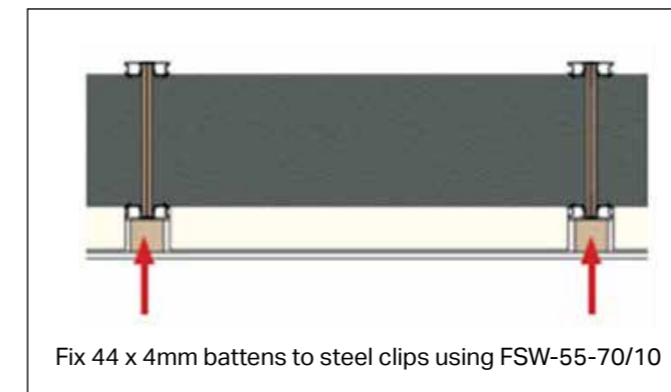

Foil backed plasterboard may then be fitted to the timber battens in the normal way.

## Plaster guidance



This image is the plaster line detail when at 12.5° using 25mm frame extensions.

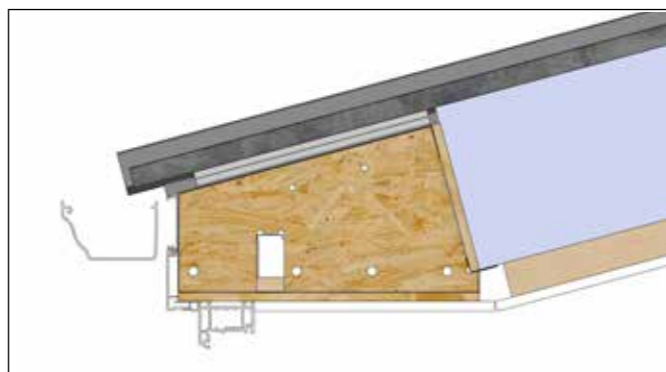

This image is the plaster line detail when at 15°.

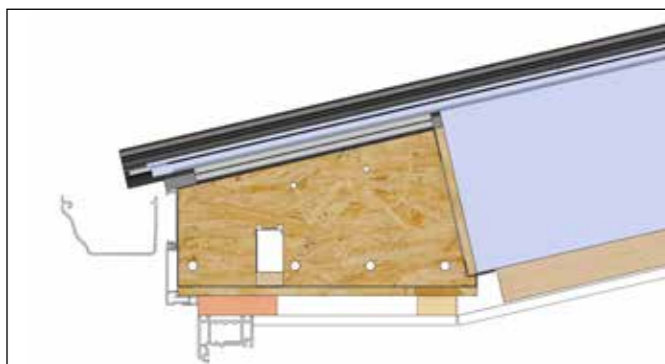

This image is showing the plaster line at 12.5° to 15° using 100 x 25mm timber packer (not supplied).

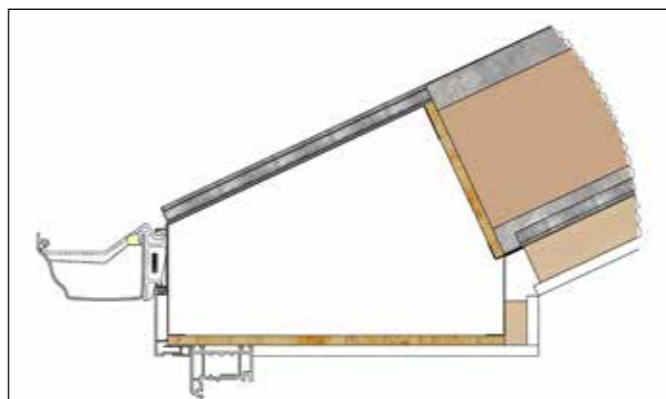

This image is the plaster line detail when 25°.

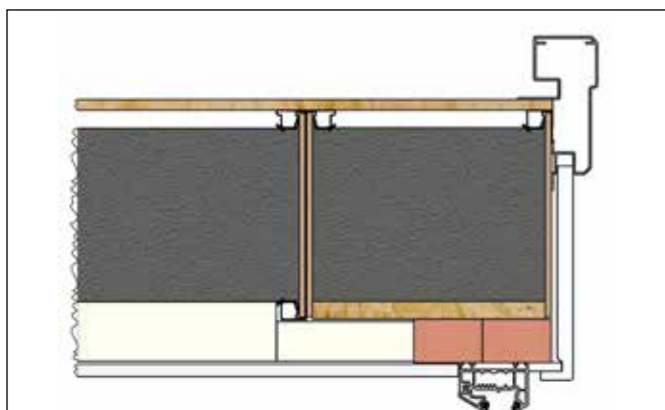

This image is showing the plaster line detail for a standard gable front. 44 x 70mm timber required above the gable frame.

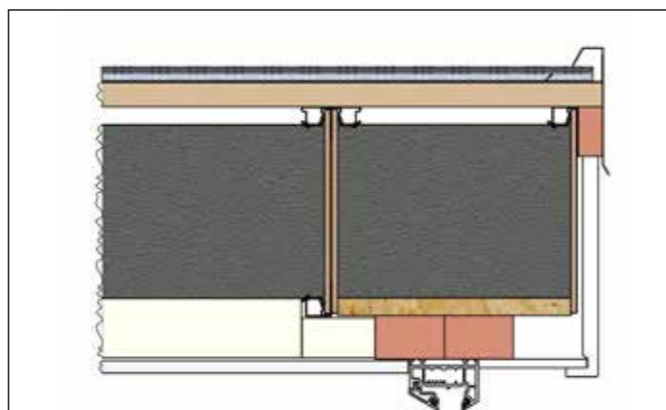

This image is showing the plaster line detail for an extended gable front. 44 x 70mm timber required above the gable frame.

## Gable End & Lean to

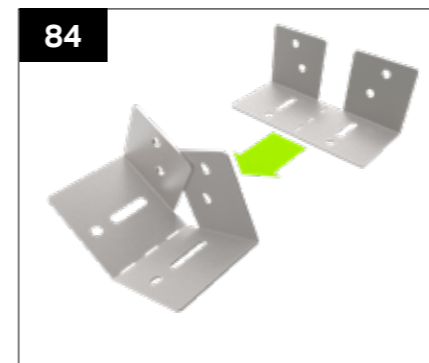

84 Bend provided gable ridge support bracket WPGR001 to the correct roof pitch along the perforated line.

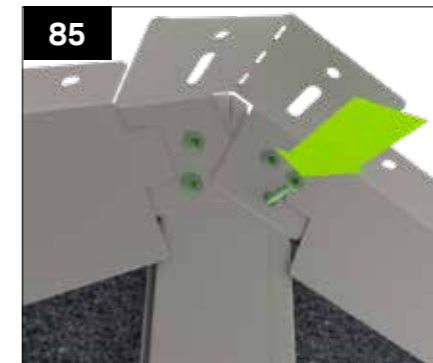

85 After gable wall is complete, attach the previously bent bracket to the apex of the wall and the internal angle brackets WPCA/1, aligning the upper angled faces with the top of the wall panels, using the GPHS050 screws through the pre punched holes into the vertical steel clips.

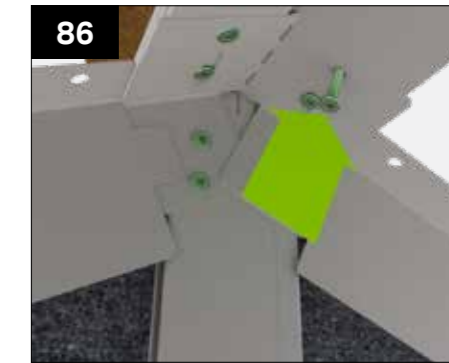

86 Position ridge and temporarily secure in bracket slot using the GPHS050 screws. Ensure level and walls are plumb, then tighten screw and add screws through final fix holes.



87a Before fitting roof gable panels, pre fit supplied steel angle bracket/s WPCA/2, aligning with the outer edge of the half clip (these could be in 2 lengths dependant on panel length). Align the upper bracket with the top edge of the gable panel and the second bracket (if required) against the first. Secure using the GPHS050 screw.



87b If an extended soffit has been specified, measure from the external edge of the panel by 320mm and mark a line. Align the steel angle bracket/s with this line and secure into the OSB using the GPHS050 screw.



88 Fit gable panels to the top of the wall panels, pushing the steel bracket against the external clips. Secure to the wall panel clips using the provided GPHS050 screws through the pre punched holes.

## Gable End & Lean to

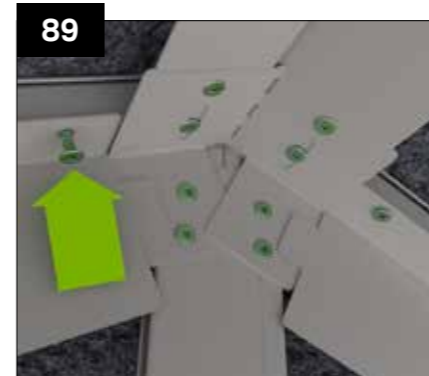

89 Secure gable panel on the inside through the previously attached angle WPCA/1, through the pre punched holes using the provided GPHS050 screws.



## Flat Roof



Lower the Flat Roof beam into position onto walling panels, the clips will run up both the internal and external face of the Flat Roof beam.



Once the beam is in position fix in place using the provided GPHS fixings into the beam with two fixings and the walling panels with two fixings for every full clip.



Externally secure each walling clip into the beam as shown using two GPHS fixings 30mm from the top and bottom of the beam and two fixings into the walling panels.



On corners, fit the clips to the beam as per the walls. Fit the 2 additional corner angle brackets WPF001 to each side as shown using GPHS050 screws.



Unroll the membrane over the walls allowing this to sit slightly below DPC level (around 10 mm). Ensure that any joins in the membrane overlap by a minimum of 100mm horizontally and 150mm vertically. This can be clipped in place using the membrane clips provided. The membrane detail at the top of the wall is shown in the following steps.



When applying the membrane this is to be folded over at the top of the clips as shown above.

**Follow the Flat Roof installation guide for the roof construction. Once complete return to this guide for the external finishing of the walls.**

## Finishing

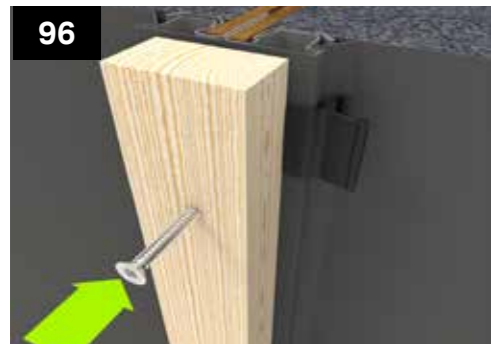

Position a 25mm batten, treated timber (optionally provided) or alternative, against the clips trapping the membrane in place. At apertures this batten is positioned inline with the opening. Secure the batten to the walling full and half clips using the winged fixing screw (provided with battens).

Please Note: - Excluding Flat Roof, the battens on the external wall clips will be shorter than the clip length and should be set down from the underside of the eaves to allow for adequate ventilation.

The top of the batten should be positioned as outlined in table below. This differs for each roofing system.

Roof	External Batten Position
Tiled Roof	21mm below eaves underside
Hybrid/Glass Roof with cornice	40mm below eaves underside / 10mm below cill
Hybrid/Glass Roof with cornice	29mm below eaves underside / 10mm below cornice
Flat Roof	Battens run up the front of the beam



At the host wall fold the vertical DPC over the top of the membrane prior to battening out.



Position a 25mm batten, treated timber (optionally provided) or alternative, against the clips trapping the membrane in place. At apertures this batten is positioned inline with the opening as shown in image B. Secure the batten to the walling full and half clips at 450mm centres using the winged fixing screw (provided with battens). **Please Note: - Excluding Flat Roof, the battens will be shorter than the clip length and should be set down from the eaves level or other air flow obstructing roof elements by 12mm to allow for ventilation.**



Above openings, fit a horizontal batten across the top of the opening at 450mm centres with the base of the batten aligned with the opening in the wall.



Fit the soaker trim to the wall at a slight angle using the GPHS fixing at 450mm centres, giving it a roughly one-degree fall. The battens should terminate above and below this trim.



Using tape provided seal along the joint at the top between the soaker trim and the membrane.



At corners battens should be fixed as shown. This ensures that wall finishes (claddings) at the corners are well reinforced.



If a structural post has been specified, the batten arrangement is altered, and a steel angle is used to allow for the cement board to be easily fitted and reinforce the corner.



At the base of the wall attach the perforated ventilation trim to the battens. This allows for ventilation and drainage but inhibits vermin/insects.





## Finishing

hup!  
The better way to build

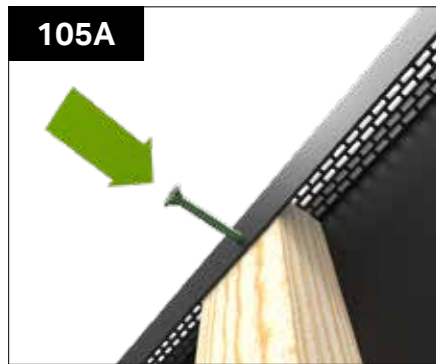

Excluding Flat Roof, if timber battens or wall finishes (claddings) are used a ventilation trim is required at the top of the wall. **All systems** will require a ventilated trim to be fitted below a window if timber battens or claddings are used. A 10mm continuous gap should be left between the top of the cladding and the eaves level to allow for ventilation. The ventilation trim is to be fitted to the battens using the GPFS screw to inhibit vermin/insects.



Where apertures are found at ground level fold up the excess DPC and temporarily fix in place, this can be done with tape or other method.

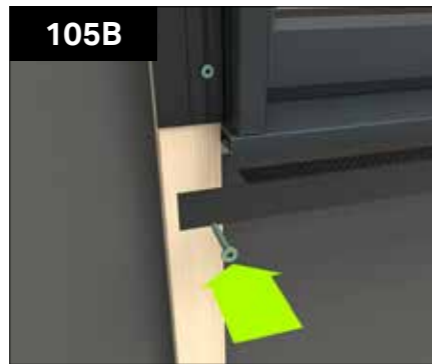

Install windows and doors in position. The internal face of the frames (if 70mm frames are used) is to sit 70mm inboard from the external wall steel datum (or 145mm from the internal), this is the outermost steel on the top tray.



Internally fold up the excess DPC and temporarily fix in place, this can be done with tape or other method.



Around the perimeter of the walling openings fit the optional aperture trim. This will need to be cut into the cill. This is secured into the battens using GPFS at 400mm centres.

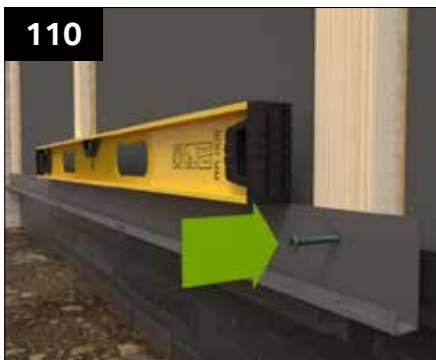

Using the DPC level on the host wall, or the bottom of the base tray, align the lower edge of the cement board starter trim WPST/1 or WPST/2. Ensure level and secure to the face of the battens through each pre punched hole using the GPFS050 screws.



Referring to the location plan position the cement board against the battens, ventilation trim and aperture trims. This should sit at DPC level and if timber battens are used a 10mm continuous gap must be left at the top between the board and roof structure to allow air flow.

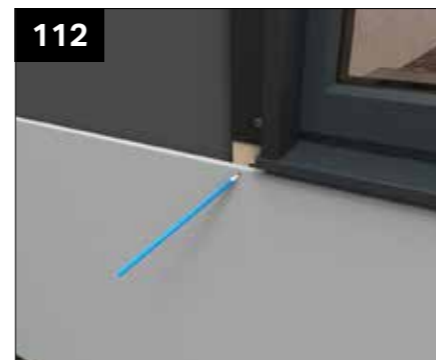

Mark the boards with the batten positions to ensure the fixings can be aligned and secured into the battens below.

hup!  
The better way to build

### Weather consideration

It is advisable to check the weather before you begin the Brick Mesh application - rain can make the adhesive ineffective. If it starts to rain partway through the application, cover what you have already applied with a tarpaulin or polythene to ensure it is protected. You could even erect a covering where you are working, but ensure the area is fully undercover.

## Wall Finishings - Brick Mesh

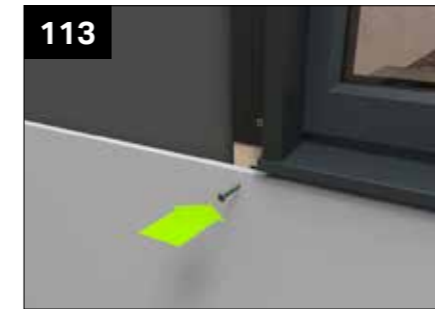

The boards can then be secured to the walling system by screwing the GPFS fixings through the cement board into the battens. These fixings should be fixed at 150mm centres around the perimeter and at 300mm centres vertically in the centre of the board.



The formed corner can then be applied to the wall, by evenly pressing into the adhesive. Take care when handling to prevent damage to the Brick Mesh. To ensure this is level a stringline or laser level should be utilised.



Prepare the area around the build. We recommend covering the ground with a DPC or other material to allow any spillages of the adhesive to be easily scooped up and prevent wastage. Laser levels, horizontal string lines or other should be set up.

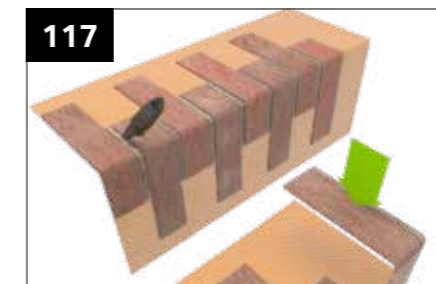

If at the corner the alternate brick pattern is required, the corner needs to be moved down by one brick to create the alternate brick pattern. The bottom brick can be cut from the mesh corner using a utility knife. If required at the top of the wall this brick can then be applied to the wall.

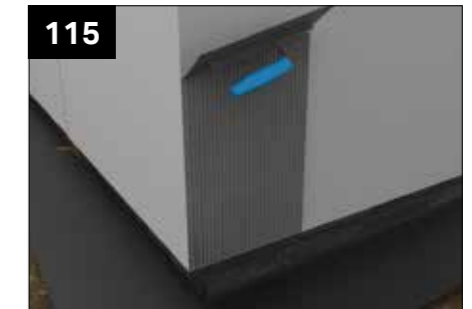

Ensure you've worked the adhesive into a good consistency before you begin applying it. You can use a water spray to add moisture if necessary. Working from the bottom corner outwards using a notched adhesive trowel, the adhesive is to be applied evenly across the wall. It may be advisable to work in smaller sections e.g. 8 courses vertically at a time.

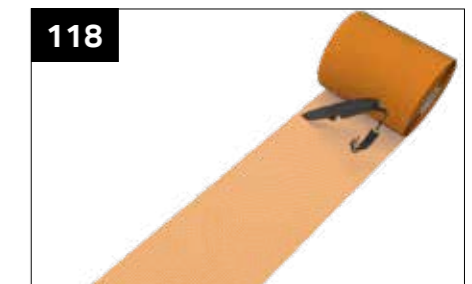

A roll of mesh is supplied with the Brick Mesh. This is to be applied where there are vertical joints between the mesh panels. Where there is no mesh behind a brick panel e.g. at door apertures or if mesh has been cut off a panel, ensure you place a piece of mesh behind it - always place mesh where there is no mesh.

If you need to cut a Brick Mesh panel, ensure you do it from the bottom so you don't lose the mesh at the top.



Where there are vertical joints in the Brick Mesh between standard flat panels, a layer of mesh is to be applied vertically at this location. This is to reinforce the joints. At the corners the mesh is extended, therefore this step is not required for standard flat panels to corners. The mesh is to be pressed into the adhesive on the wall then more adhesive is to be applied over this mesh.



A standard brick mesh panel can then be positioned next to the corner, and over the previously applied mesh strips positioned at joints. Press this panel evenly into the adhesive and ensure that it is positioned level to prevent any run out.

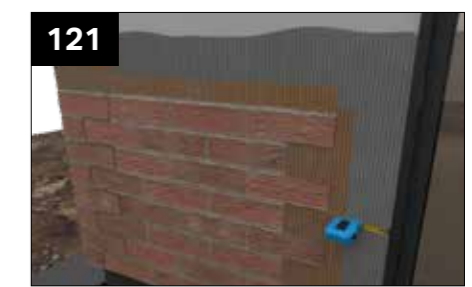

Where the brick is required to be cut (this will be necessary at the openings and depending on size it may be necessary where the standard mesh panels reach the opposite corner), measure and mark where the cut is required.



## Wall Finishings



122  
On a flat work surface, score the brick using a utility knife. The mesh can then be bent, and the knife ran through once more to cut the remaining mesh. If the cut being made is castellated, follow the castellations of the bricks.

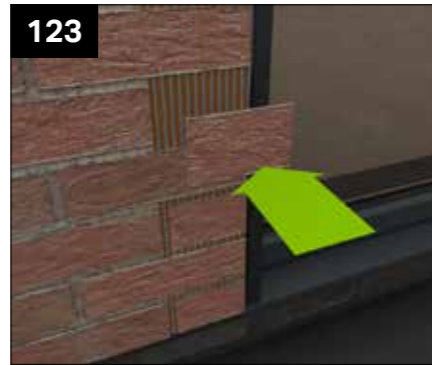

123  
Any smaller gaps in the brickwork can be filled using small offcuts of brick mesh from other areas of the build, this will aid in material optimisation.

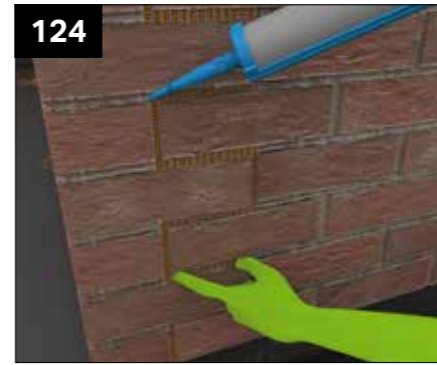

124  
Where joints have been made, some of the adhesive will squeeze through. This should be dressed using either a tool such as a paint brush or a gloved finger. It may be necessary to apply additional adhesive in these areas to point them in. This task is made considerably easier by filling a 'mortar gun' with adhesive and using this to apply adhesive to the wall.

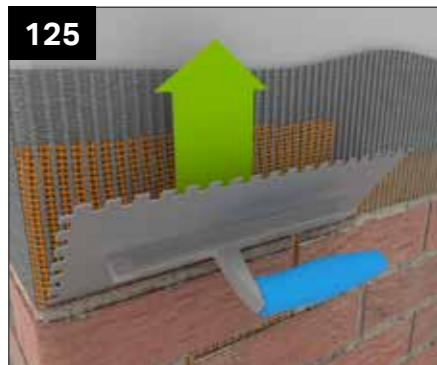

125  
If a pause in work is to occur, please ensure any excess adhesive is scraped from the build. Once hardened this may interfere with the fitting of the following mesh panels. We would recommend completing a continuous horizontal run before taking this step.

## Wiring Details

### WARNINGS

- **ALL WIRING MUST BE CARRIED OUT BY A PART P QUALIFIED ELECTRICIAN TO THE LATEST BS7671 REQUIREMENTS FOR ELECTRICAL INSTALLATIONS!**
- If cables need to be run up the wall or around apertures, **THE CABLE MUST BE SHEATHED IN A FLEXIBLE CONDUIT!** This is to avoid contact between the cable and the EPS.

## Cable Management Panels

A cable management panel option is available for running cables around the perimeter of the build. It is supplied on every panel if this option is selected:

- The channel is set at 450mm above the DPC level and allows holes to be drilled between panels through the hardboard and cables fed through.
- The channel is deep enough to cater for socket back boxes.

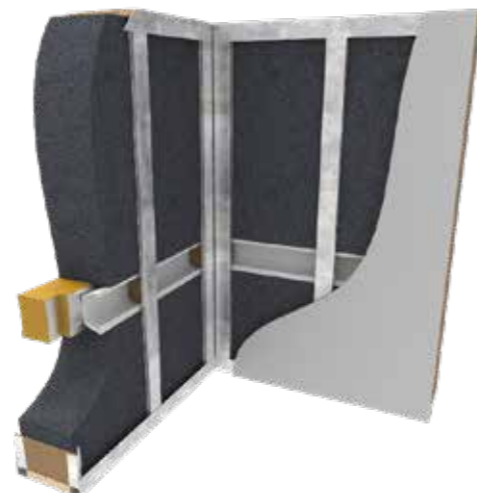
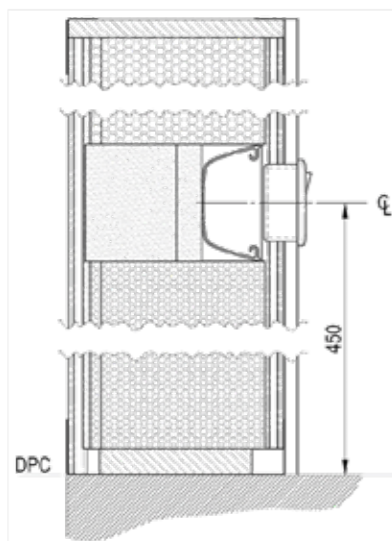

## Wiring Details

### Alternative Methods (Glass and Hybrid Roofs)

If a cable management panel is not specified, the wiring can be run around the perimeter of the eaves and then dropped vertically to the required position of the socket or switch. When running the cable across or down the face of the EPS, **the cable must be run in a flexible conduit.**

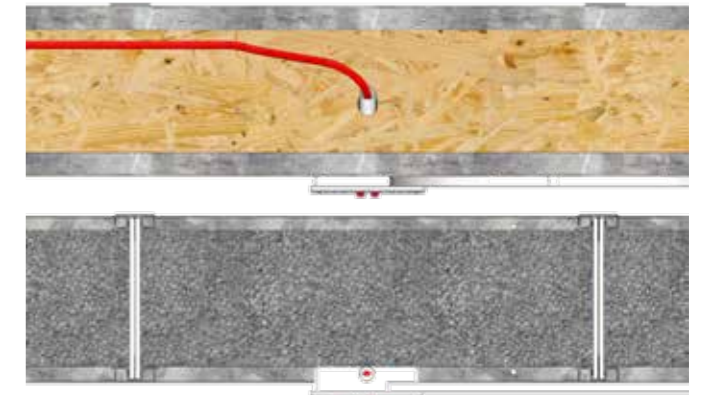
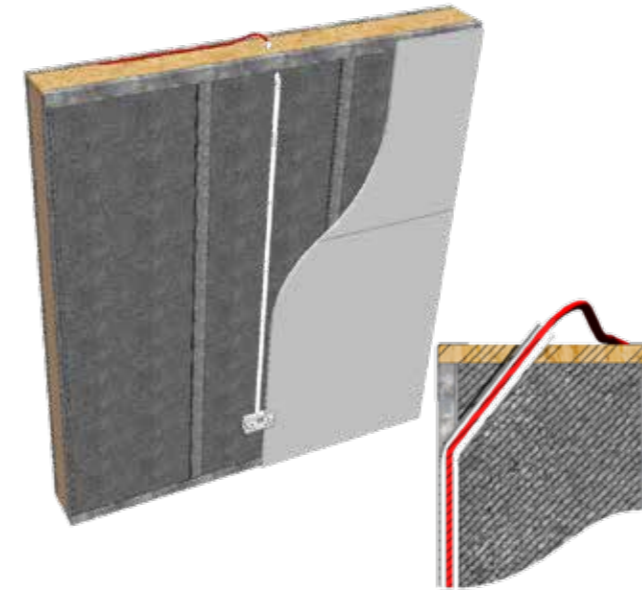

Drill hole through top tray and EPS to thread conduit through.

### Alternative Methods - (Tiled and Flat Roof)

If a cable management panel is not specified, the wiring can be run around the perimeter of the eaves and then dropped vertically to the required position of the socket or switch. When running the cable across or down the face of the EPS, **the cable must be run in a flexible conduit.**



#### Option 1

Drill a 20mm diameter hole either side of the clip into the back of the beam. Push in a grommet to protect the cable against the steel edge. Using a rigid wire pull string through the holes to enable feeding cable through.

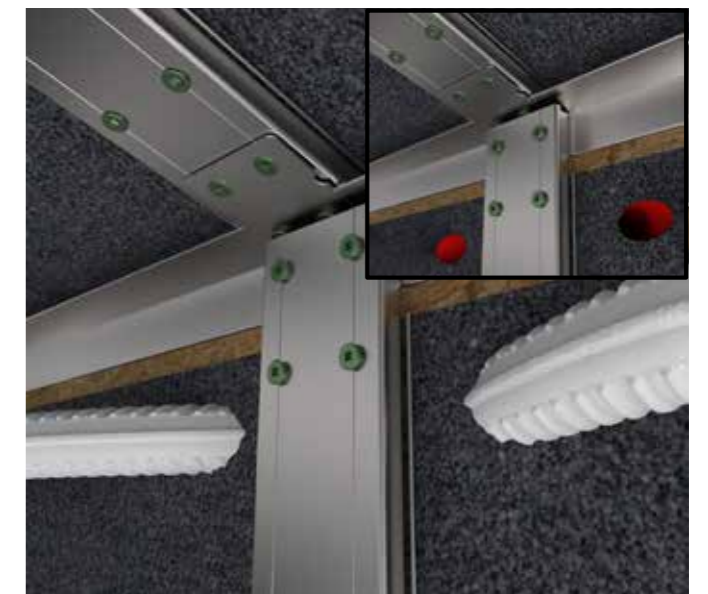

#### Option 2

Drill an angled 20mm diameter hole (shown in red) either side of the clip into the EPS and break through the hardboard behind the steel clip. Using a rigid wire pull string through the holes to enable feeding cable through. **Ensure that cable is in conduit to isolate from the EPS.**





# Installation Guide

Version 1.0 | 04.23

JN: 9056 | PC: HUG001\_v1

**hup!** - A Building Revolution from Ultraframe

**hup!**<sup>®</sup>  
The better way to build